

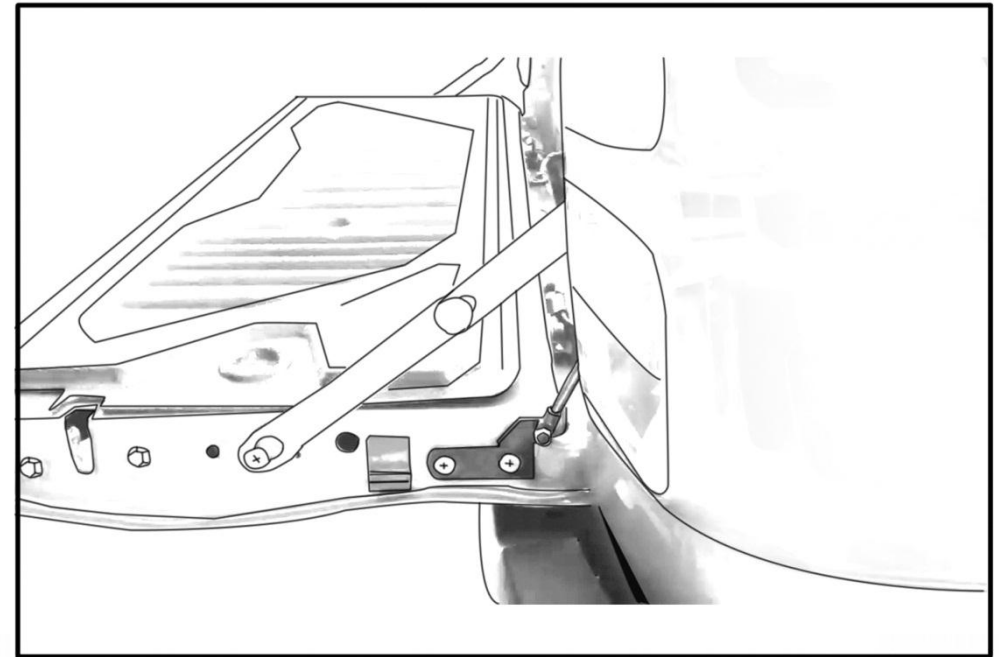

FITTING INSTRUCTION

TOYOTA REVO



Note :

Apply WD40 or grease to the moving parts regularly for good performance of the product.

Patent Pending Worldwide

Patent Pending Worldwide

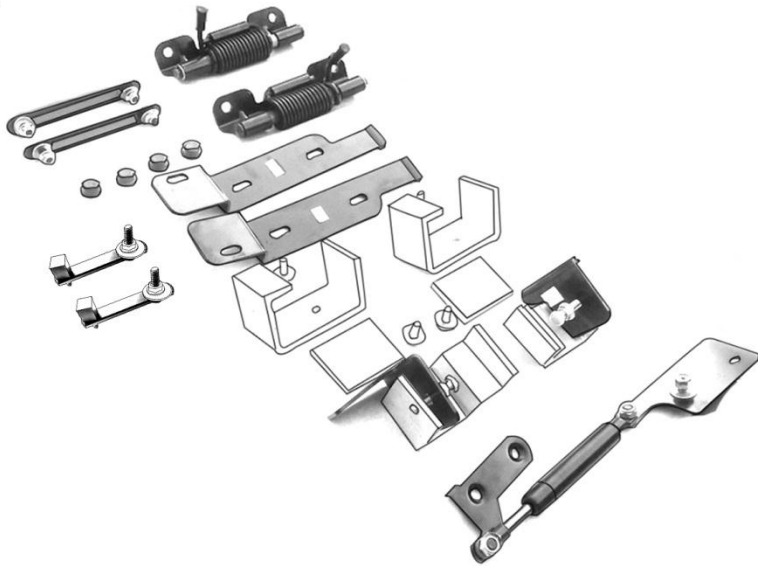
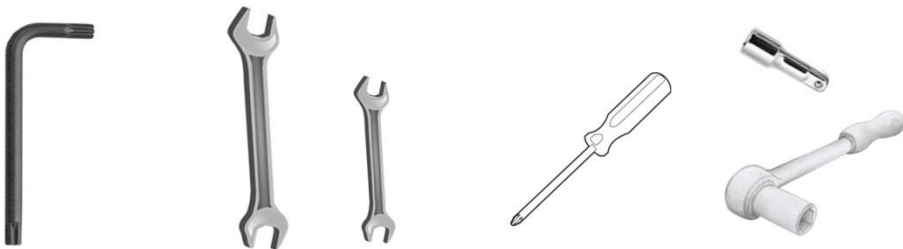
Part listTooling

No.12 No.10

No.12

CAUTION

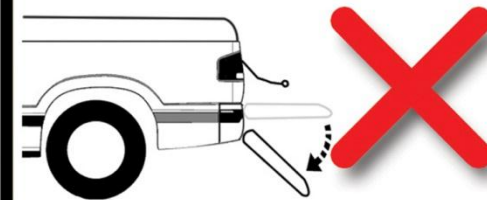

Do not take off
tailgate cable
and drop down
the tailgate

11. Install damper bracket (with tailgate)

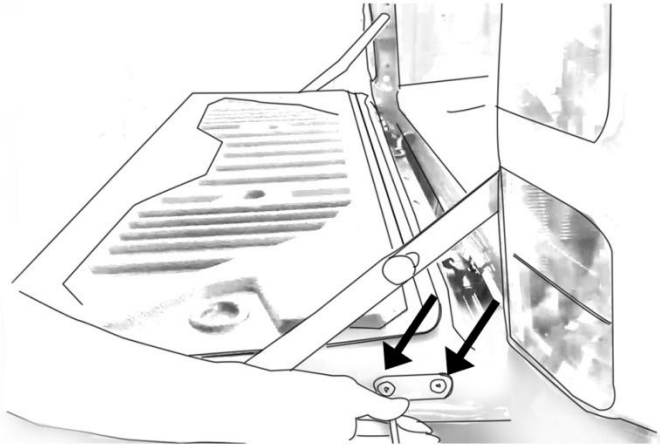

take off original bolts

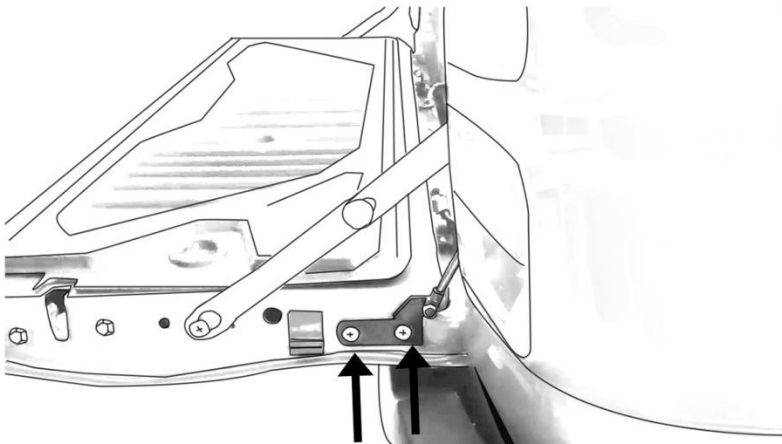

put damper bracket and tighten back the original bolt.



1. Take off tailgate cover plate

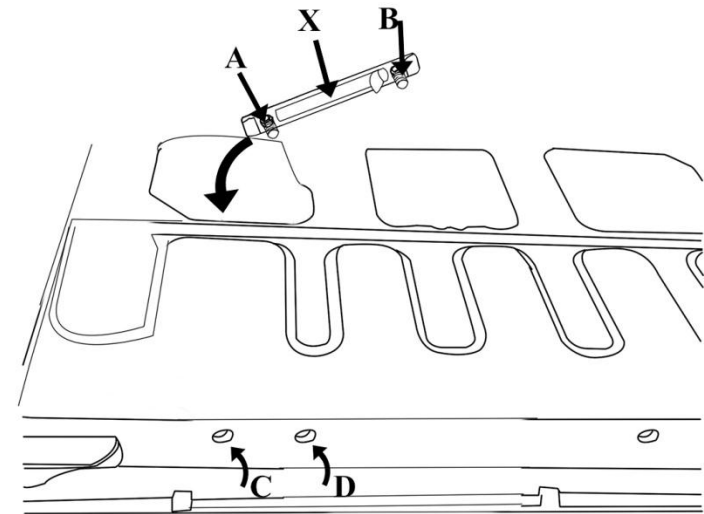

2. put bracket X into the tailgate (peel off glue tape and stick it inside the tailgate). Place bolt A&B through hole C&D

Process #3 - #5 is done while tailgate in close position.

**3. Put ProLift bracket with tailgate
(from the bottom)**

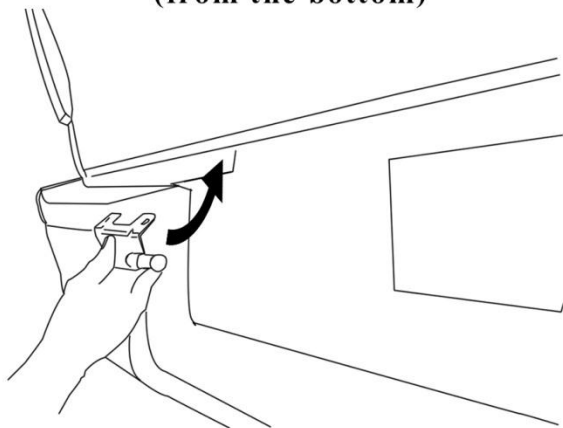

4. Tighten nut E&F

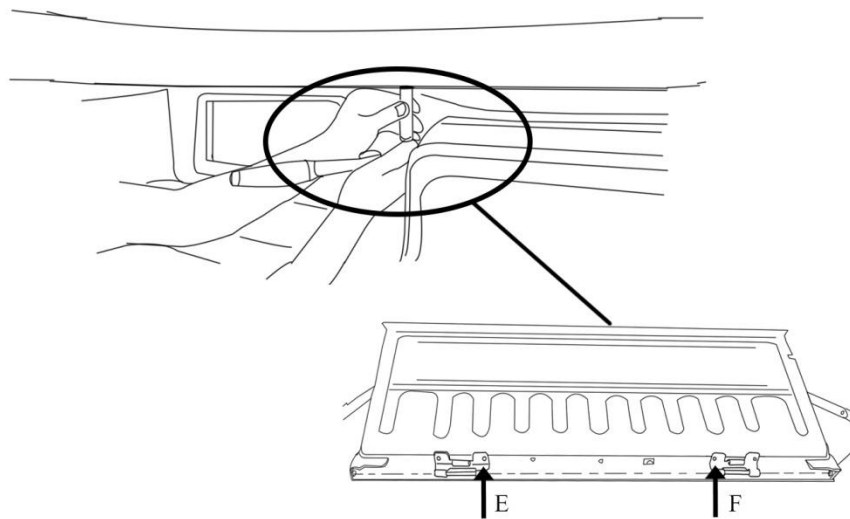

10. Install damper bracket (with bed)

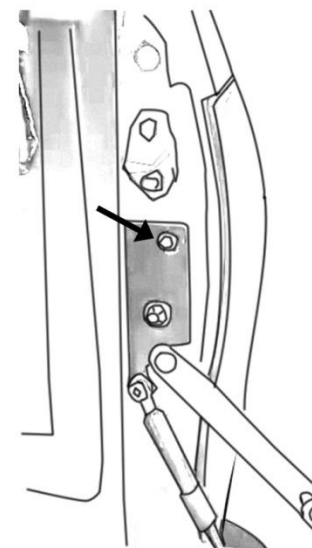
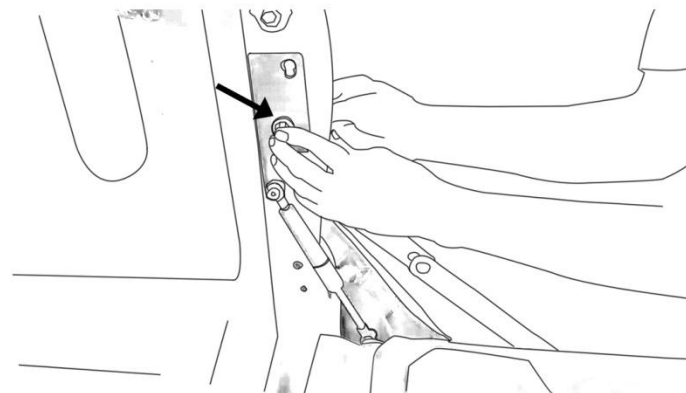

**9. Take off rubber bumper and cut as picture below
and put it back**

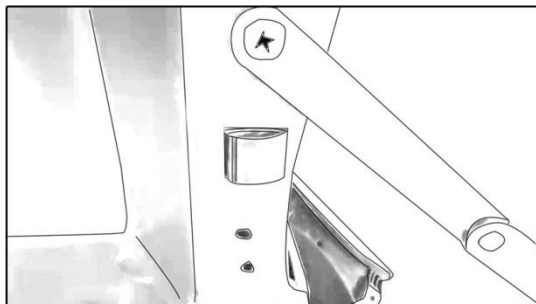
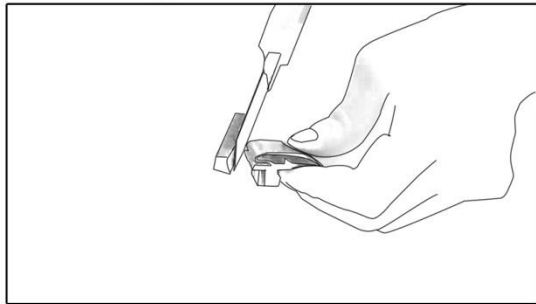
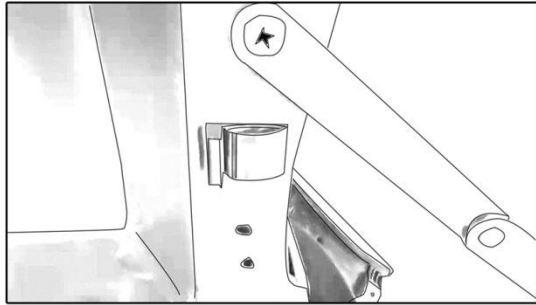

Install spring leaning bracket

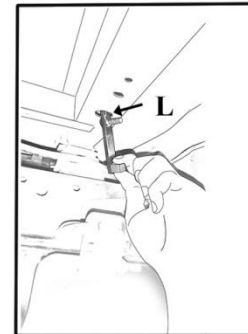
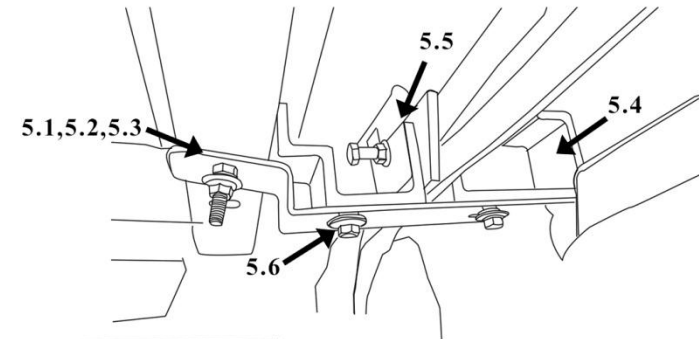

**5.1 put bolt-welded bracket (L)
to the position.**

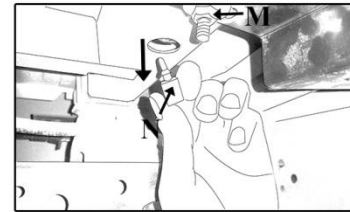

**5.2 put main bracket in position.
Finger tighten nut M,
pull out rubber (N) from bolt-welded bracket (L)**

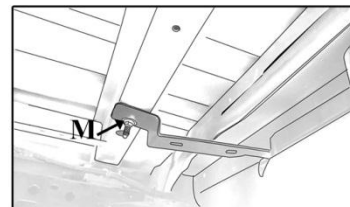

5.3 tighten (M)

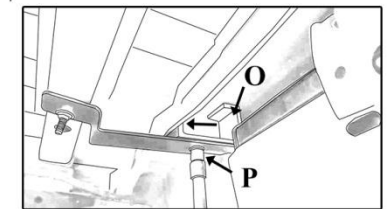

**5.4 put aluminium part (O) in place
and tighten bolt (P)**

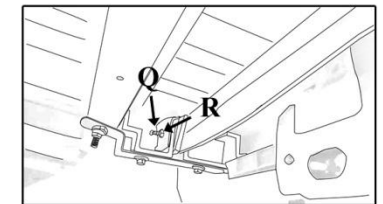

**5.5 put bracket (Q) in place
and tighten bolt (R)**

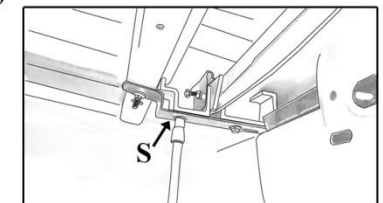

5.6 tighten bolt (S)

6. Tighten nut G&H

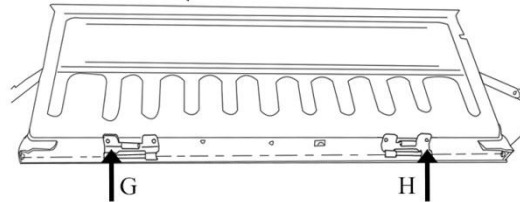
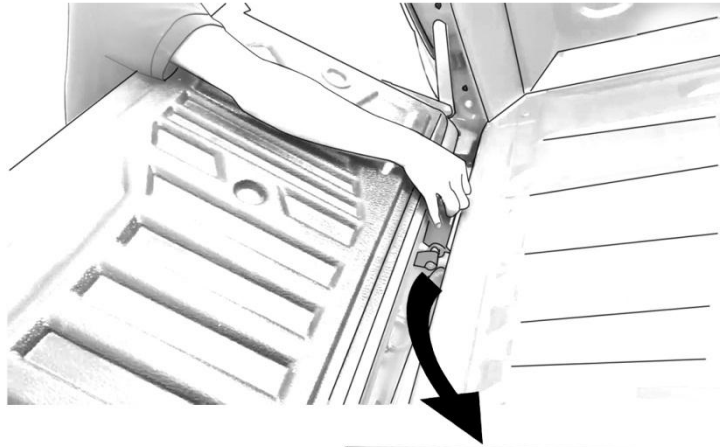

7. Put plastic plugs cover nuts

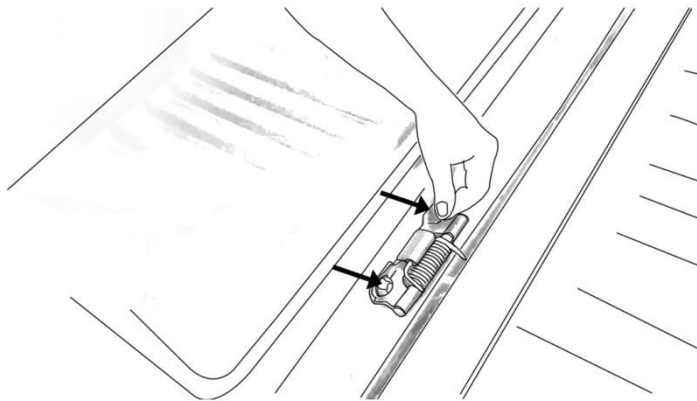

Install damper

8. Take off rear light

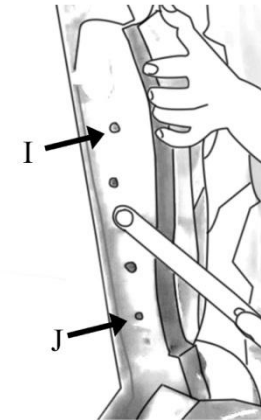

Unbolt I&J

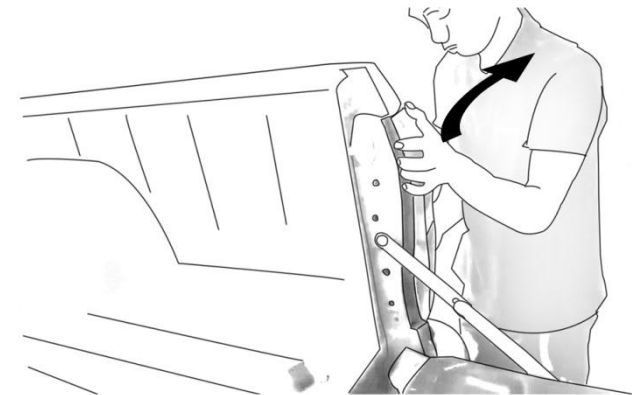

Take out rear light cover
(direction to the side of the truck)